

# Data Sheet



Article number: 071581350545040

Description: Cardan drive shaft 0.158.135.001  
S=545 X=40 Bore with keyway

## Measures

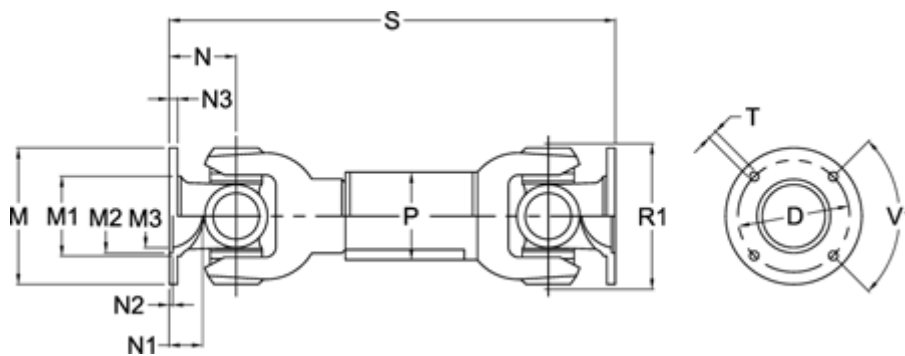

D	= 130 +0,1	N1	= 25	T	= 12 B12
Extension X	= 40	N2	= 3 +0,5	V1 degrees	= 45
Flange diameter M	= 150	N3	= 12		
M1	= 104	Number of Flangeholes	= 8		
M2	= 90	P	= 90x4		
M3	= 84	R1	= 150		
Max. Bending Angle degrees	= 35	S min	= 545		
N	= 90	Spline dim. DIN 5480	= 60x2,5x22		